



HDD Series

Direct Draw Refrigerator with Swing Door

HDD Series
03/28/19
Item # 13217

- HDD-2-59
- HDD-3-80
- HDD-2-59-S*
- HDD-3-80-S*
- HDD-3-69
- HDD-4-95
- HDD-3-69-S*
- HDD-4-95-S*

Item #: _____
 Project: _____
 Qty: _____
 AIA#: _____

Features

- ▶ Heavy duty 18-gauge stainless steel top
- ▶ Stainless steel interior with LED lights
- ▶ Polished stainless-steel insulated towers with plated brass faucet

- Black vinyl coated exterior front, sides, and rear
- Stainless steel threshold protects door frame from damage when loading and unloading
- Front breathing, side mount refrigeration is easily accessible by sliding out front for cleaning and service
- Zero clearance requirements sides and rear
- Electronic controller with digital LED display (°F or °C)
- Cabinet walls and doors are insulated with 2" environmentally friendly, CFC free foamed-in-place polyurethane
- Keg cushion to protect floor and allow air to circulate below kegs
- Self-closing doors come standard with locks
- Cabinets are designed to maintain interior temperatures between 33°F to 38°F
- Engineered to maintain NSF-7 temperatures in 100°F ambient



HDD-2-59



HDD-2-59-S*



HDD-3-69(-S*)



HDD-3-80(-S*)

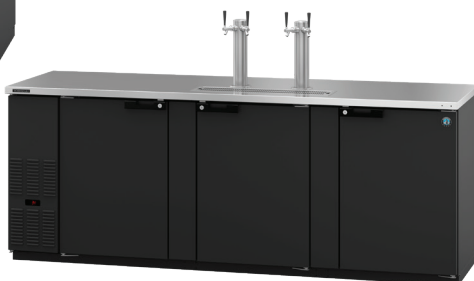

HDD-4-95(-S*)

Model	Cabinet Dimensions W x D x H	Capacity (AHAM) cu ft	Door(s)	Tower(s)	Tap(s)	1/2 Barrel(s)	HP	Amps	Voltage	NEMA Plug	Shipping Dimensions W x D x H	Shipping Weight
HDD-2-59(-S*)	59.5" x 29" x 36.88"	18.45 ft ³	2	2	3	3	1/3	5.2	115	5-15P	63.5" x 33" x 42"	343 lbs.
HDD-3-69(-S*)	69.5" x 29" x 36.88"	22.14 ft ³	2	2	3	3	1/3	5.2	115	5-15P	73.5" x 33" x 42"	370 lbs.
HDD-3-80(-S*)	80" x 29" x 36.88"	26.79 ft ³	3	2	4	4	1/3	5.2	115	5-15P	84" x 33" x 42"	396 lbs.
HDD-4-95(-S*)	95.5" x 29" x 36.88"	32.53 ft ³	3	2	4	5	1/3	5.2	115	5-15P	101" x 33" x 42"	429 lbs.

Options & Accessories

* (-S) Stainless Steel Exterior option available - Made to order.

Warranty

3 Year parts and labor / 5 year compressor





HDD Series

Direct Draw Refrigerator with Swing Door

HDD Series
03/28/19
Item # 13217

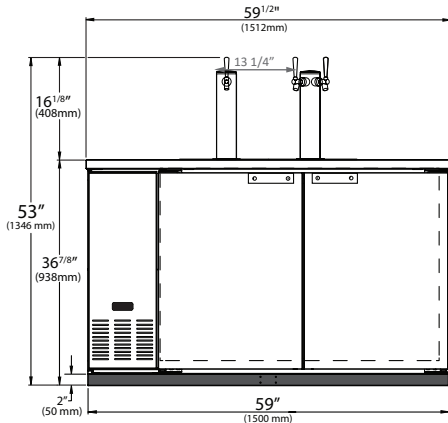

HDD-2-59(-S) Front View

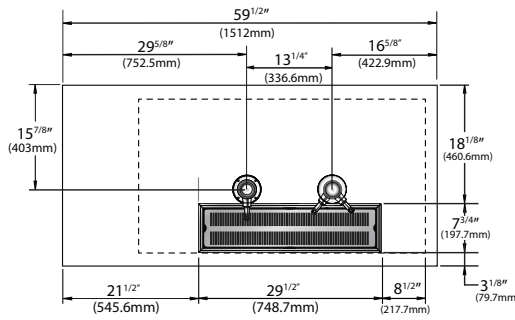

HDD-2-59(-S) Plan View

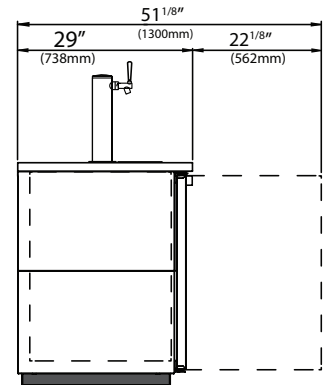

All Models Side View

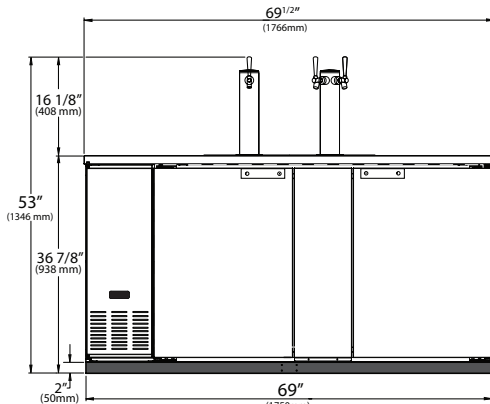

HDD-3-69(-S) Front View

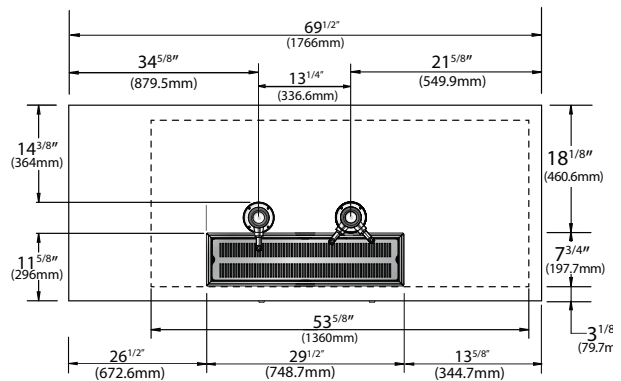

HDD-3-69(-S) Plan View

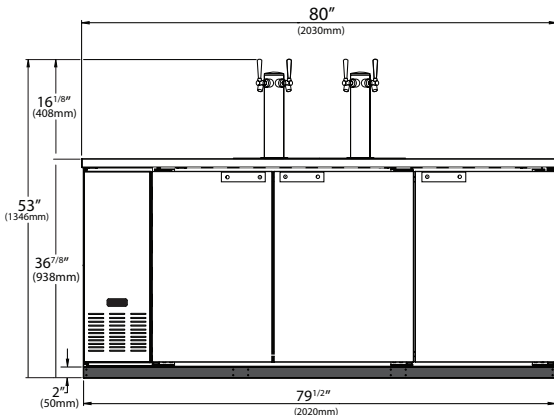

HDD-3-80(-S) Front View

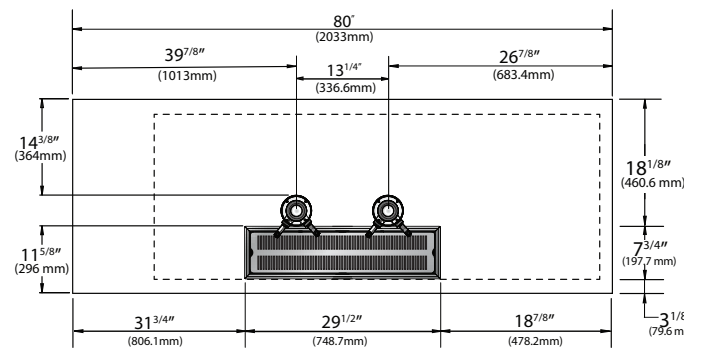

HDD-3-80(-S) Plan View

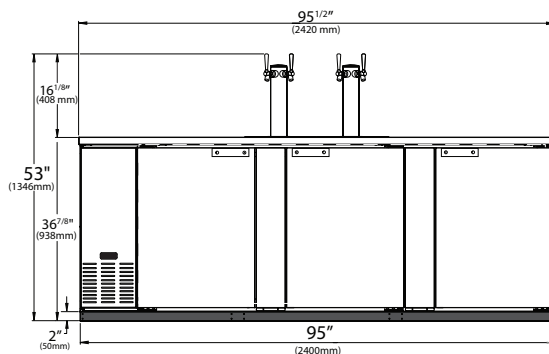

HDD-4-95(-S) Front View

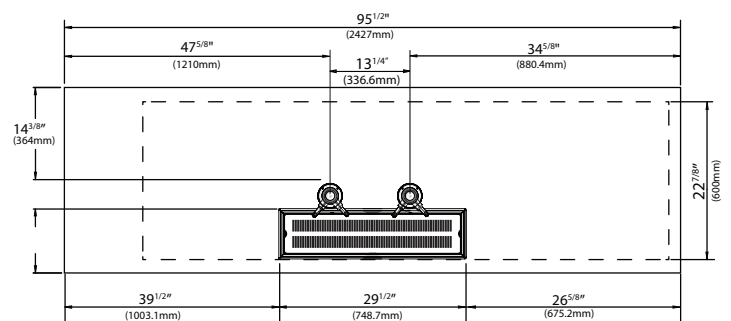

HDD-4-95(-S) Plan View